



CYCLE RACKS

SARIS

BIKE CORRAL

The Bike Corral turns one car parking stall into bike parking for 10 bikes. It's a great use of space and a low cost option for more customer parking, it frees up sidewalk space for pedestrian foot traffic and communicates a commitment to bike friendliness.

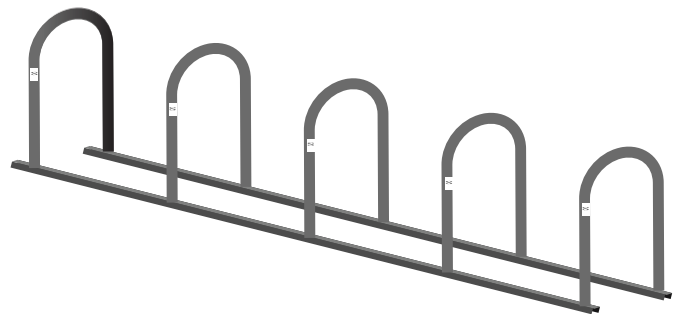

Specifications -2 3/8" OD schedule 40 steel

Model #	# Bikes	Type of mount	weight	length	width	height	Space Requirement
2140	10	Freestand	244 lbs.	156"	18.6"	37.2"	80" x 240"
2142	10	Freestand	255 lbs.	156"	18.6"	37.2"	80" x 240"

Note: Saris Parking Systems representatives can assist with custom layout and spacing to meet your room dimensions and desired bike capacity.

Bike Corral

Recommended Spacing

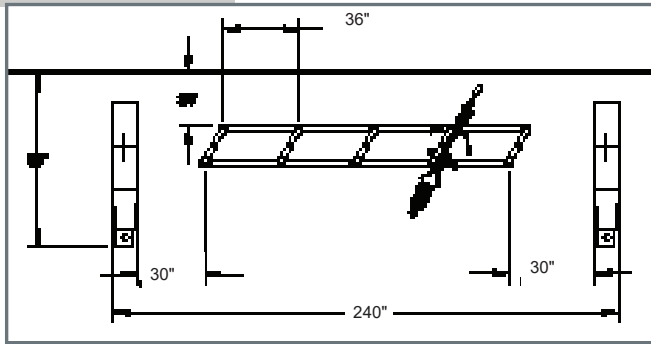
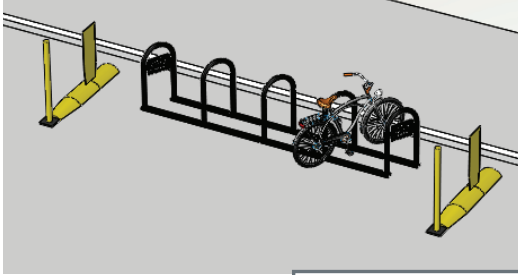

Product Details

- Easy access for maintenance and street cleaning
- Only 4 points of installation and can be anchored into asphalt
- Solid construction resists impact damage; constructed of 2 3/8" OD schedule 40 steel
- Durable powder coat finish is corrosion resistant and has long term life span
- Meets APBP bike parking standards
- Customization and branding options available

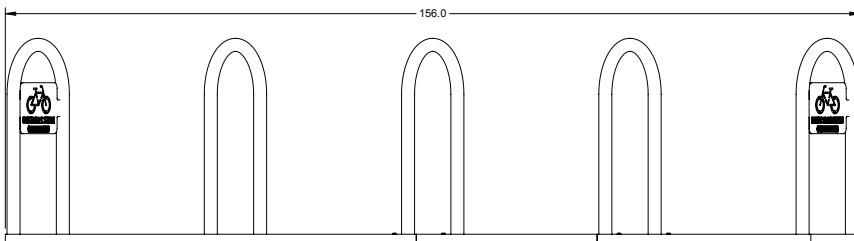
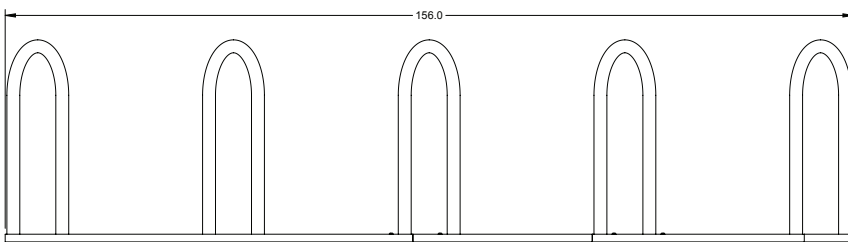

Saris Bike Corral as manufactured by Saris

Product Information



10 bikes per rack



2 3/8" round tube
3" x 1 1/2" c-channel for hoops



Powder Coat
Galvanized
Thermoplastic



Can be freestanding or use recommend #6259 for concrete installation and #6267 for asphalt installation



24" from curb
36" from rack to end of parking spot

Anchors must be purchased separately



Standard Colors

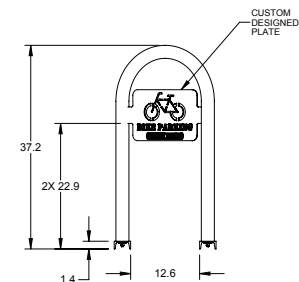
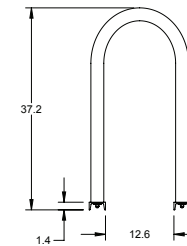

Downloadable product resources available online:

